

## HOW TO MEASURE AN ANGLED OR CURVED BAY WINDOW



A simple measure guide from **The Shutter Store**

We're here to help

✉ [hello@theshutterstore.co.uk](mailto:hello@theshutterstore.co.uk)

☎ 0800 0747 321

🌐 [www.theshutterstore.co.uk](http://www.theshutterstore.co.uk)

## Before you start you will need:

- A good quality steel tape measure
- A spirit level
- Paper and pen
- To print out your chosen frame templates (found at the back of this guide)

### Tips!

1. Note down your sizes.
2. Go have a break, then come back to double check your sizes before you place your order.
3. You may wish to upload a clear photo of your window with your order. This helps our team have a full understanding of your needs.

## What is an Angled or Curved Bay?

An Angled or Curved Bay has two or more windows that join at an obtuse angle (between 90 and 180 degrees).

Each section of your bay window will have its own shutter. You will need to use our frame templates to measure the correct sizes for each part of your bay.

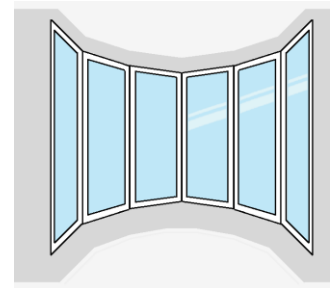
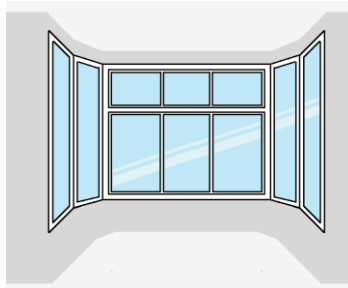
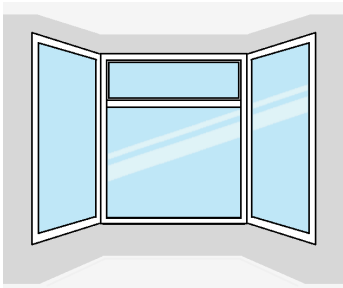

## How many Frame Sides?

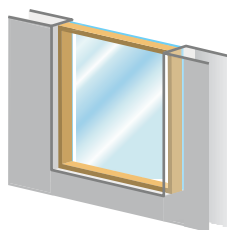

**Full Height & Tier on Tier Shutters for Windows**

Frame Sides: All

Recommended for maximum sturdiness

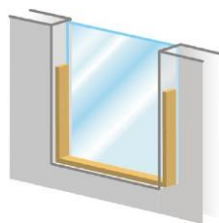

**Cafe Style Shutters for Windows**

Frame Sides: Left Right Bottom

Not advisable with the Z Frame With Sill Cut option



**Full Height Shutters for Doors**

Frame Sides: Left Right Top

Removes trip hazard

## Important to Note:

If your windows opens **Inwards** contact us before measuring. You may need an alternative fitting for your window.

We're here to help

 [hello@theshutterstore.co.uk](mailto:hello@theshutterstore.co.uk)

 0800 0747 321

 [www.theshutterstore.co.uk](http://www.theshutterstore.co.uk)

## Step 1: Choose Your Frame

### Option 1 – Double Insert L Frame (Outside Mount)

The Double Insert L frame comes with pre-drilled holes on the FRONT FACE of the frame.

It can be mounted directly onto the window frame or architrave.

It should be fitted onto a flat surface, which can also accommodate the screw fixings.

This option is typically suited to Sash window bays, or bays that do not have a suitable recess to fix into.

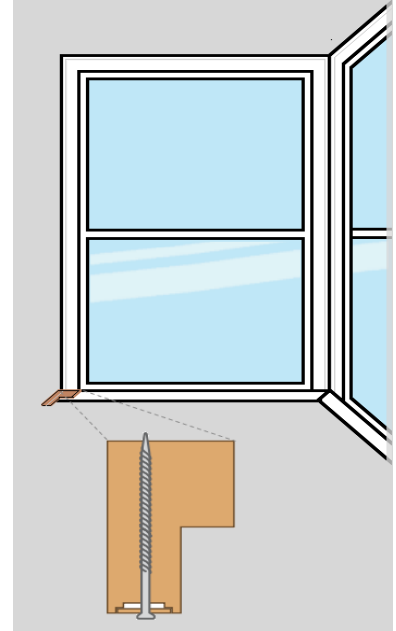

### Option 2 – Side Insert L Frame (Inside Mount)

The Plain L Frame is supplied with pre-drilled fixing holes on the INSIDE of the frame.

This frame is fixed into the windowsill and the top of the recess. It should also be fixed into the recess walls on the far left and right of the bay. You can also screw the uprights frame to frame for extra stability.

It can be positioned tight against the window, or pulled forward to leave space for handles, vents or trim. Just remember that you must fit your shutters in the same place as you positioned the templates when measuring.

This is a good option if you do not want to drill into your window frames.

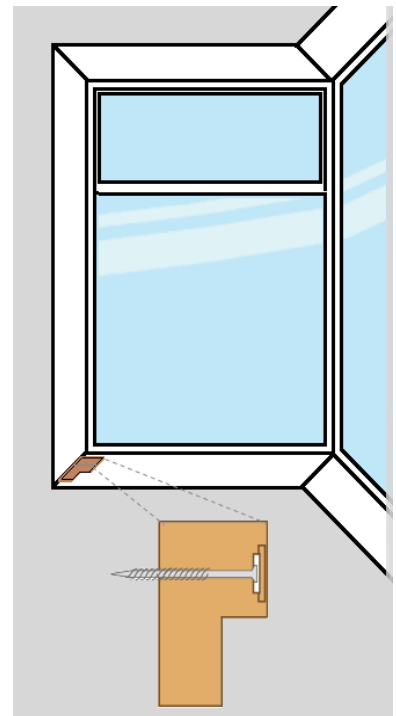

**Important:** Both types of L frame are supplied with pre-drilled holes and cover strips to hide the screw heads on installation.

We're here to help

 [hello@theshutterstore.co.uk](mailto:hello@theshutterstore.co.uk)

 0800 0747 321

 [www.theshutterstore.co.uk](http://www.theshutterstore.co.uk)

## Step 2: Choose Your Slat Size & Frame Depth

Choosing the correct depth of frame is very important, it will ensure that your slats have clearance to tilt without fouling the window or any obstructions.

1. Decide which slat size you would like to order (64mm, 76mm, 89mm)
2. Measure any handles or obstructions which project from the window. **Top Tip:** Think about where the back of the shutter frame will be and measure how far the handles protrude over the back of the shutter frame.
3. Refer to the table of recommended frame depths below to choose the right depth of L Frame.

### Choosing a Frame Depth

Our Double Insert 'outside mount' frames are 50mm deep as standard, which will accommodate some slat size and handle combinations. Frame 'build outs' are available to make your frame deeper if required to ensure the slats will tilt freely without being obstructed by window furniture. If you need a build out simply add a special note at step 4 when configuring your shutter online.

		Frame Required	Handle Projection				
			No Handles	10-19mm	20-29mm	30-39mm	40mm+
Slat Sizes	64mm	Double Insert L Frame	0mm	20mm	30mm	40mm	Contact Us
	76mm	Double Insert L Frame	20mm	30mm	40mm	Contact Us	Contact Us
	89mm	Double Insert L Frame	30mm	40mm	Contact Us	Contact Us	Contact Us

We're here to help

✉ [hello@theshutterstore.co.uk](mailto:hello@theshutterstore.co.uk)

☎ 0800 0747 321

🌐 [www.theshutterstore.co.uk](http://www.theshutterstore.co.uk)

Our Side Insert L 'inside mount' frames are 60mm deep as standard, which will accommodate some slat size and handle combinations. Frame 'build outs' are available to make your frame deeper if required to ensure the slats will tilt freely without being obstructed by window furniture. If you need a build out simply add a special note at Step 4 when configuring your shutter online.

		Handle Projection					
		No Handles	10-20mm	20-30mm	30-40mm	40-50mm	50mm+
Slat Size	64mm	Side Insert L Frame 60mm	Add 10mm Build Out	Add 20mm Build Out	Add 30mm Build Out	Add 40mm Build Out	Contact Us
	76mm		Add 20mm Build Out	Add 30mm Build Out	Add 40mm Build Out	Contact Us	
	89mm						

We're here to help

✉ [hello@theshutterstore.co.uk](mailto:hello@theshutterstore.co.uk)

☎ 0800 0747 321

🌐 [www.theshutterstore.co.uk](http://www.theshutterstore.co.uk)

### Step 3: Measure Your Window with Templates

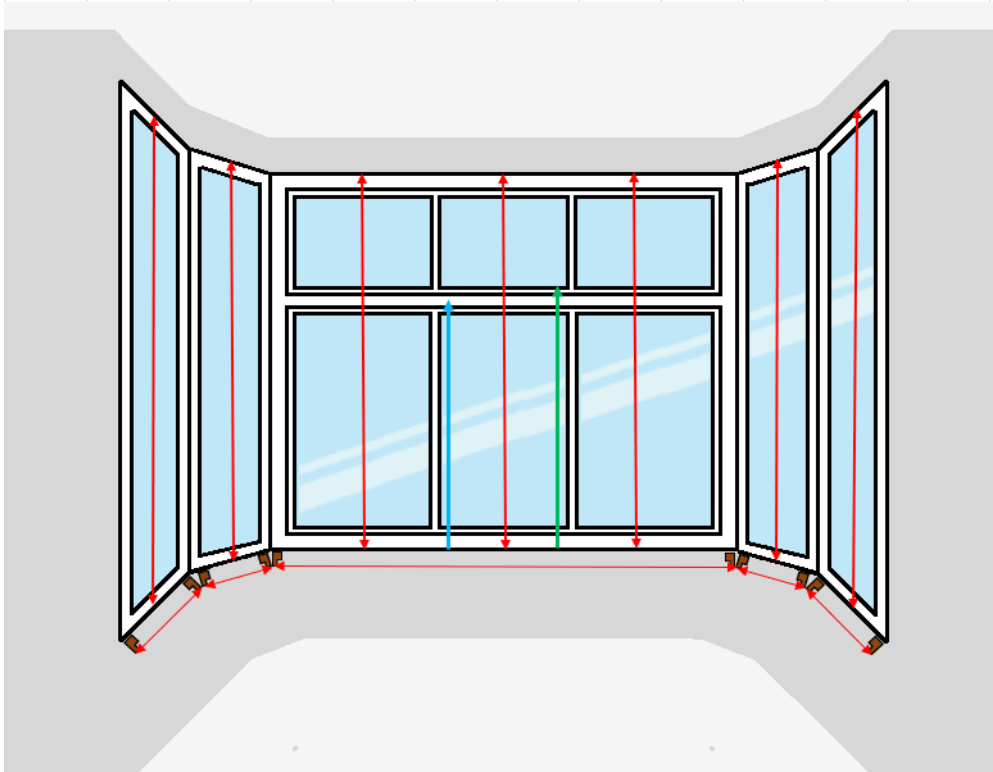

1. Position the templates as shown. Be sure not to position the frames in front of window handles. Measure the **Width** of each section including the templates (measure from outside edge to outside edge)
2. Measure the **Height** of each section. You should order the same height for all windows in the bay. This will ensure all rails and slats line up evenly.
3. We recommend deducting 4mm from your width and 4mm from your height of each shutter.
4. For a **Mid-rail** measure from the bottom up to the point you'd like the mid-rail to be centred. Use the same Mid-rail height for all sections\*
5. To measure the height of **Cafe Style** shutter or a **Tier-on-Tier Split**, measure from the bottom up to where you'd like the finished height of the lower panels, again using the same dimensions for all sections.

\* Please note manufacturing may need to move the midrail up or down from the dimensions you request to ensure that a 'whole' number of slats can fit in any given panel. If the midrail location is critical to your design, you must advise Us before Your order is finalised for production.

We're here to help

 [hello@theshutterstore.co.uk](mailto:hello@theshutterstore.co.uk)

 0800 0747 321

 [www.theshutterstore.co.uk](http://www.theshutterstore.co.uk)

### 3 Section Angled Bay:

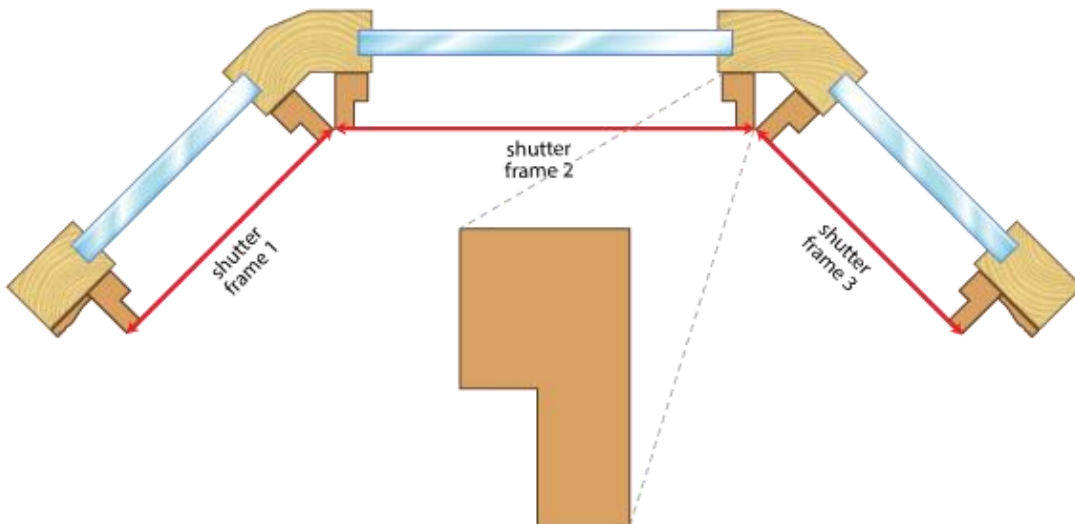

**Important:** The templates are the footprint of the vertical frames. They must not overlap each other, and they must not be positioned directly below a window handle.

We're here to help

✉ [hello@theshutterstore.co.uk](mailto:hello@theshutterstore.co.uk)

☎ 0800 0747 321

🌐 [www.theshutterstore.co.uk](http://www.theshutterstore.co.uk)

Curved Bay:

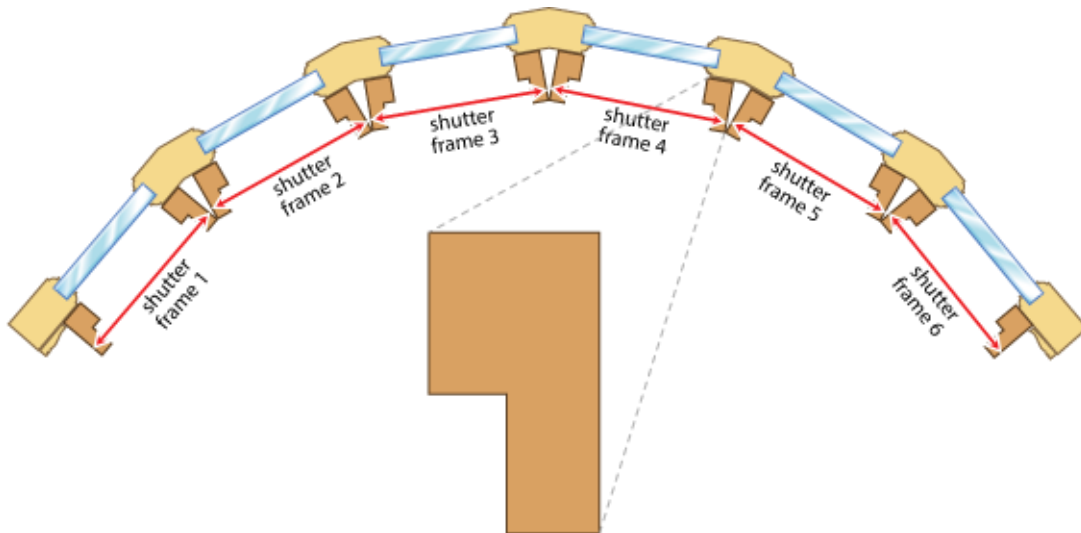
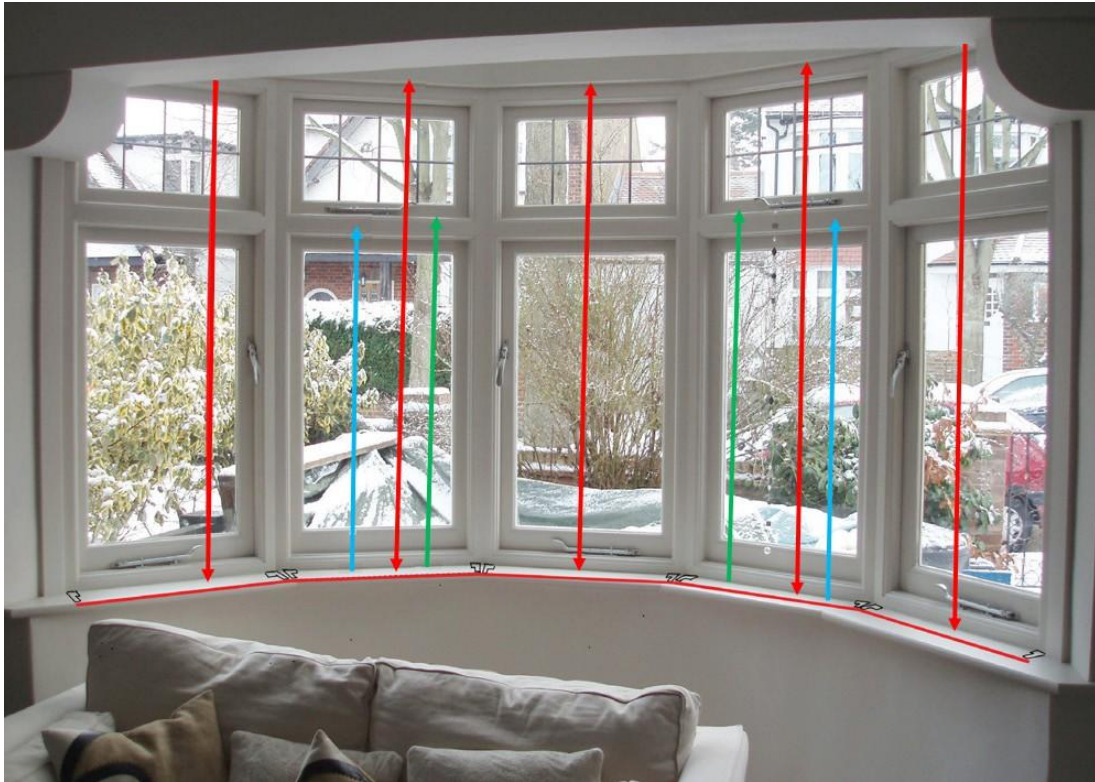

**Important:** The templates are the footprint of the vertical frames. They must not overlap each other, and they must not be positioned directly below a window handle.

\* Please note that this document is a guide only and The Shutter Store cannot be held responsible for any mismeasurements.

We're here to help

 [hello@theshutterstore.co.uk](mailto:hello@theshutterstore.co.uk)

 0800 0747 321

 [www.theshutterstore.co.uk](http://www.theshutterstore.co.uk)

## Frame Templates - Wood

Once printed, please make sure that your templates are to scale. If not, you may need to adjust your printer settings and re-print.

Double Insert  
Frame

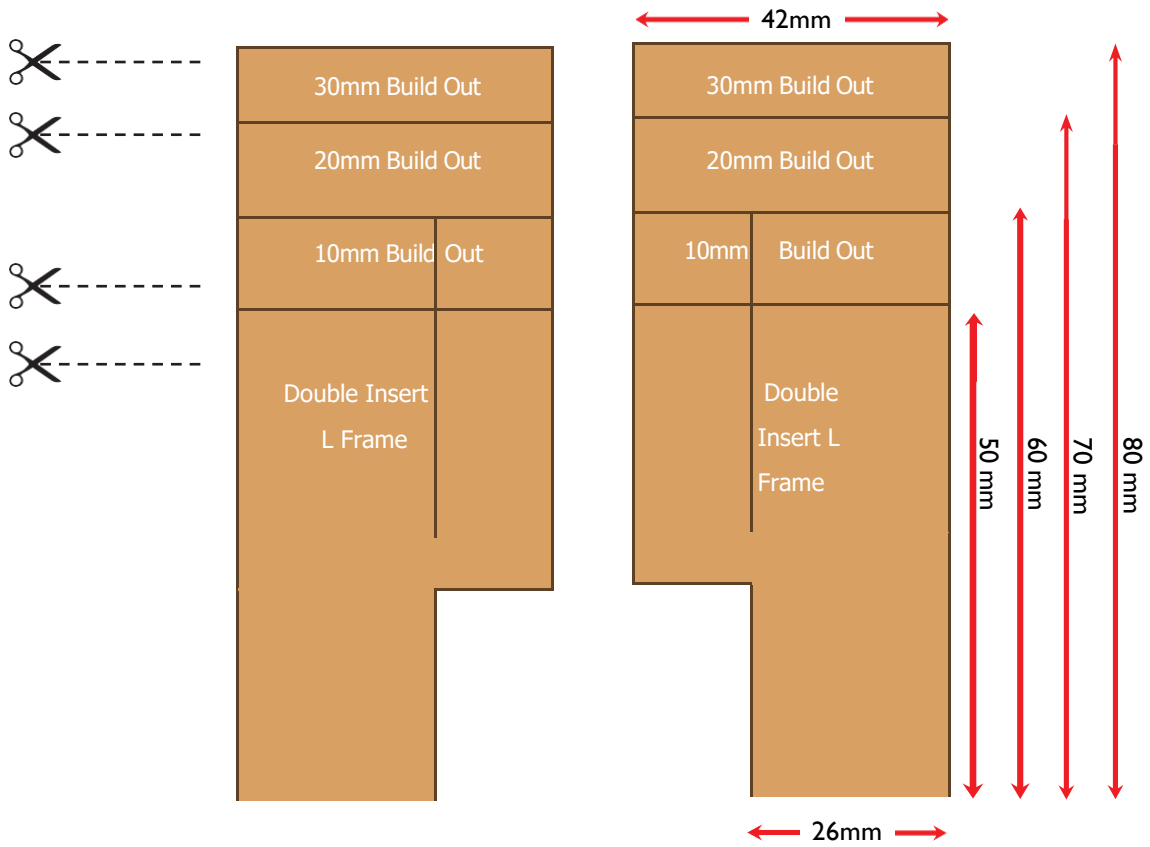

## Frame Templates - Wood

Once printed, please make sure that your templates are to scale.  
 If not, you may need to adjust your printer settings and re-print.

Side Insert L Frame

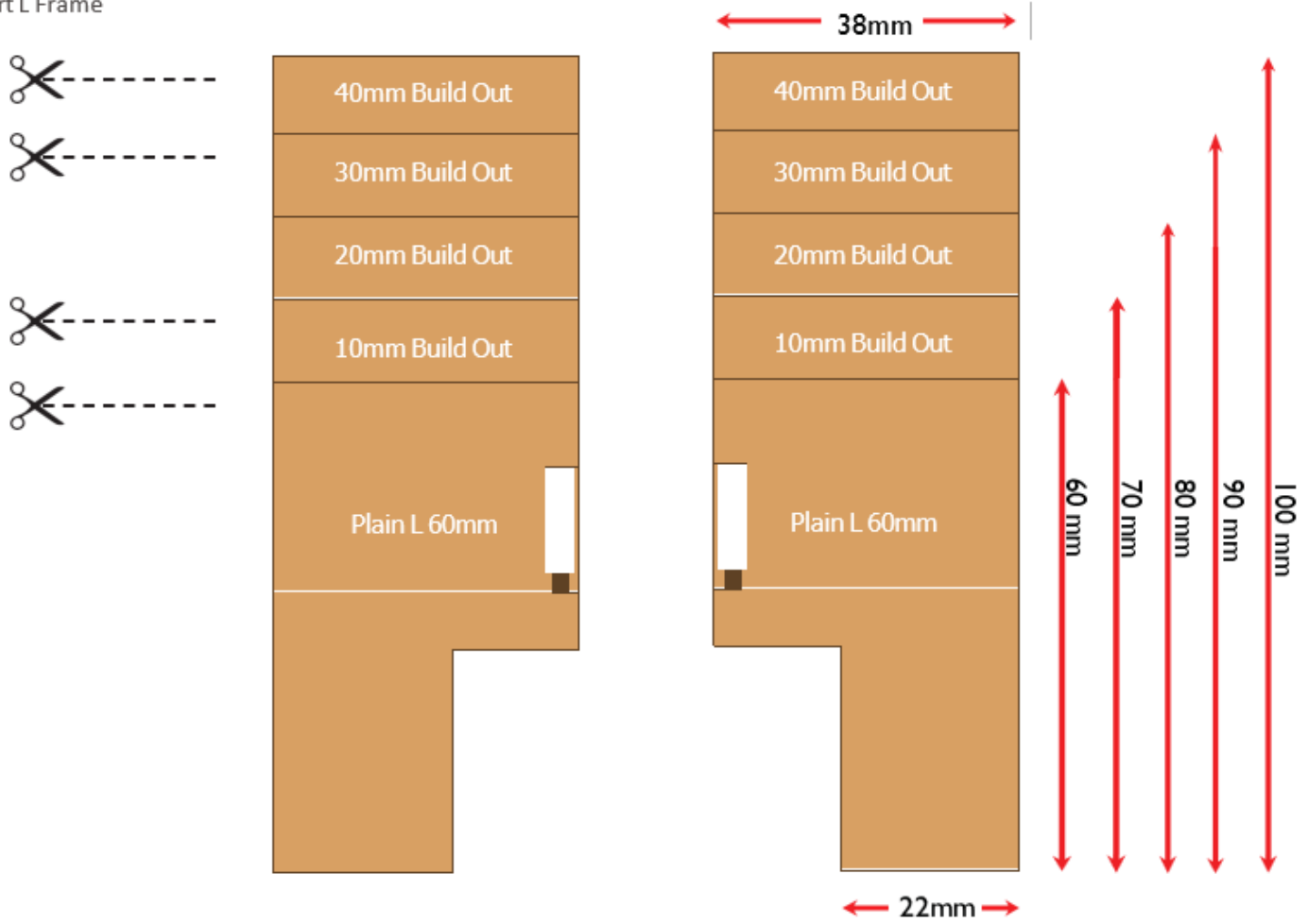

## Frame Templates - Faux Wood

Once printed, please make sure that your templates are to scale. If not, you may need to adjust your printer settings and re-print.

L Frame with cover (IM) or (OM)

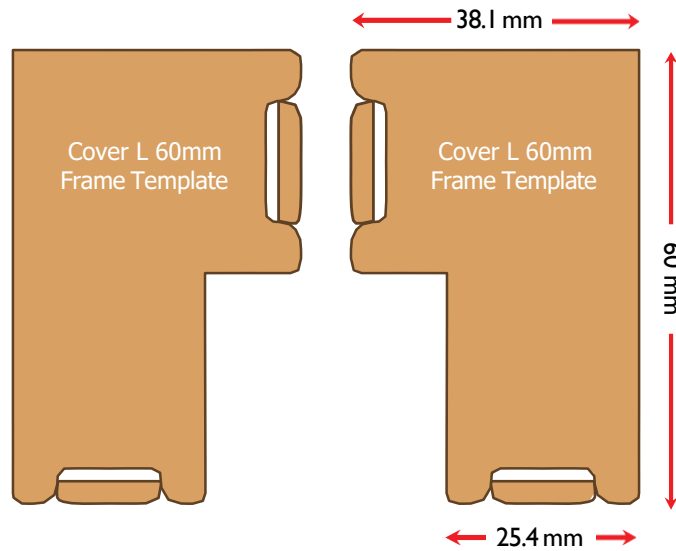

L Frame with cover (IM) or (OM)

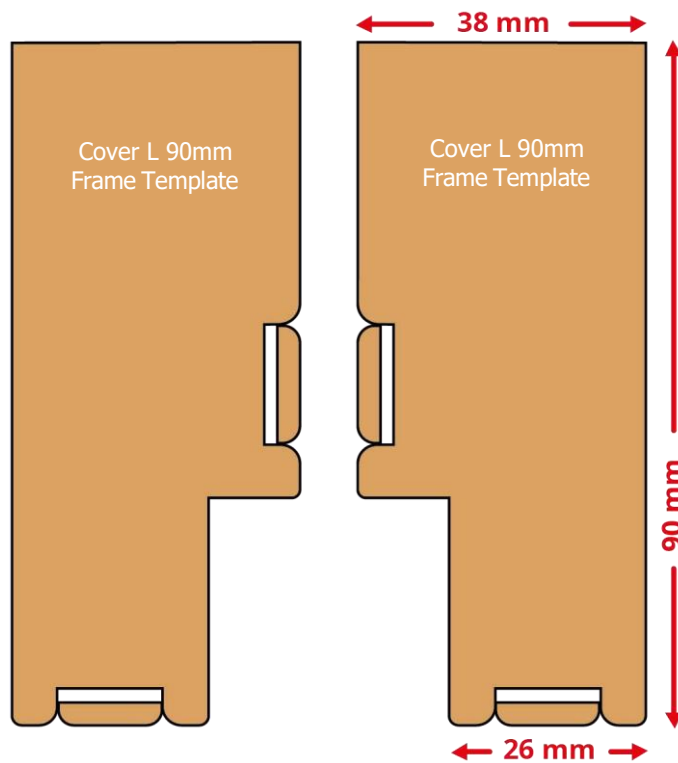

We're here to help